

NEW

AVANT 5.0 COMPACT

FREE YOUR
IMAGINATION!



AVANT

5.0 COMPACT



Vertical Gates - Vertikaltor - Portail à Elévation Verticale - Cancelli ad Alzata Verticale



FEATURES

ENG: Particularly suitable in cases where COMPACTNESS, OPENING SPEED and ECONOMY are required.

DEU: Besonders geeignet um FESTIGKEIT, ÖFFNUNGSGESCHWINDIGKEIT und KOSTENWIRKSAMKEIT zu fordern.

FRA: Particulièrement adapté aux cas où la COMPACTÉ, la VITESSE D'OUVERTURE et l'ÉCONOMIE sont nécessaires.

ITA: Particolarmente indicato nei casi in cui si necessita di COMPATTEZZA, VELOCITÀ DI APERTURA ed ECONOMICITÀ.



TECHNICAL DATA

VERSION	MOTORS	LENGHT (max.)	HEIGHT (max.)	OPENING TIME (sec.)	OPERATING TEMPERATURE	PAINTING	CATEGORY
 RESIDENTIAL INDUSTRIAL	 1	 5,80	 1,50	 15	 -20° +65°	 POWDER RAL 7016	 ENTRY LEVEL

OPTIONAL



5.0 COMPACT  



Vertical Gates - Vertikaltor - Portail à Élévation Verticale - Cancelli ad Alzata Verticale

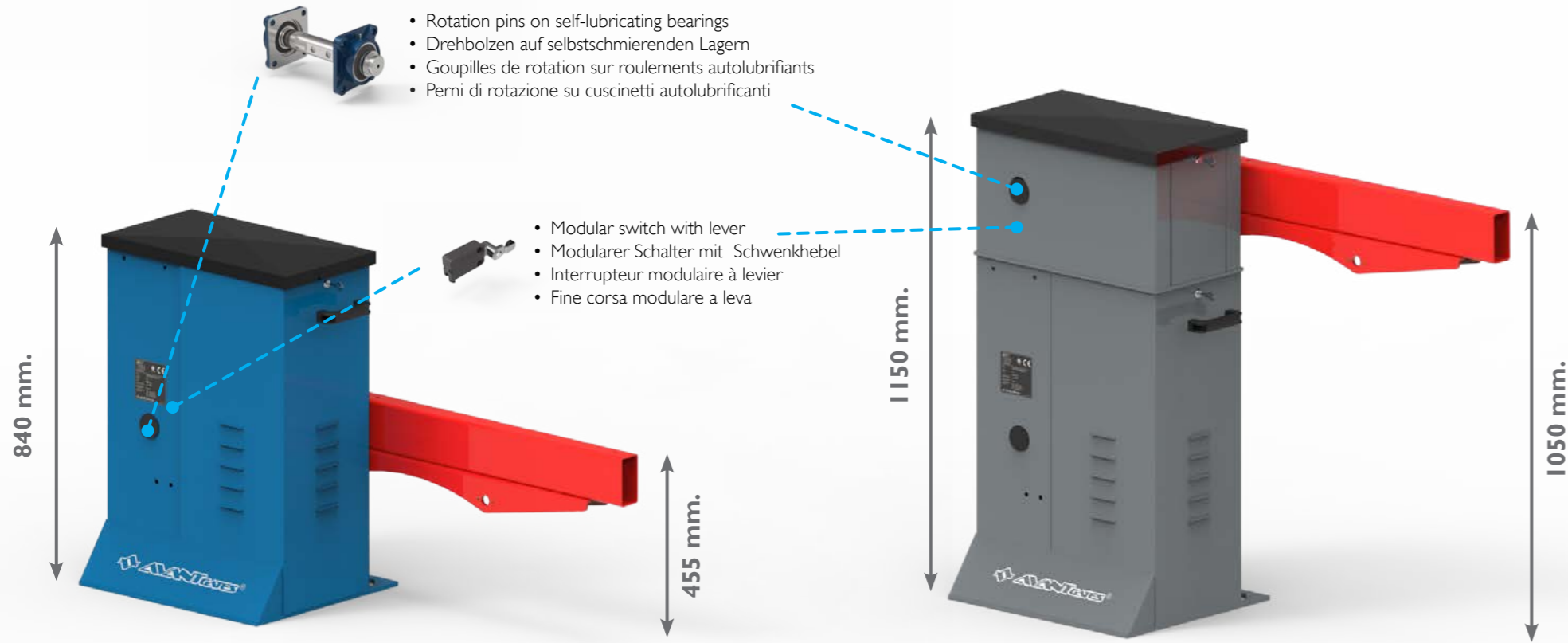

- Rotation pins on self-lubricating bearings
- Drehbolzen auf selbstschmierenden Lagern
- Goupilles de rotation sur roulements autolubrifiants
- Pemi di rotazione su cuscinetti autolubrificanti

- Modular switch with lever
- Modularer Schalter mit Schwenkhebel
- Interrupteur modulaire à levier
- Fine corsa modulare a leva

COMPACT

COMPACT+

5.0 COMPACT  



Vertical Gates - Vertikaltor - Portail à Élévation Verticale - Cancelli ad Alzata Verticale



20x40 (aluminium rods)

580 mm. (with photocells)

COMPACT+

COMPACT+



1 Avantgates 5.0 Compact NKD



2 Avantgates 5.0 Compact PNL



3 Avantgates 5.0 Compact PNL-C



4 Avantgates Compact Plus STD

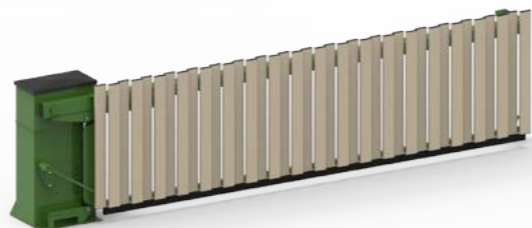

5 Avantgates 5.0 Compact Plus V-DA



Avantgates 5.0 Compact TB (page 134)

 **Frequenza d'utilizzo oraria**
Hourly frequency of use



	Dimension		Tipo Aste Rod Type	Scheda Elettronica Electronic Board	Tempo di Apertura Opening Time (sec.)	Controllo Remoto Remote Control	Luci a LED (schema 2) LED lights (schema 2)	Encoder - Potenzziometro Encoder - Potentiometer
	LUNGHEZZA LENGHT (max.)	ALTEZZA HEIGHT (min. ÷ max.)						
1 Avantgates 5.0 Compact NKD	5,80	0,46		WITH INVERTER	15	<input checked="" type="checkbox"/>	<input checked="" type="checkbox"/>	<input type="checkbox"/>
2 Avantgates 5.0 Compact PNL	5,80	0,60 ÷ 1,50		WITH INVERTER	15	<input checked="" type="checkbox"/>	<input checked="" type="checkbox"/>	<input type="checkbox"/>
3 Avantgates 5.0 Compact PNL-C	5,80	0,60 ÷ 1,50	a richiesta - on demand	WITH INVERTER	15	<input checked="" type="checkbox"/>	<input checked="" type="checkbox"/>	<input type="checkbox"/>
4 Avantgates 5.0 Compact Plus STD	5,80	1,05 ÷ 1,50	20x40 mm - Aluminium	WITH INVERTER	15	<input checked="" type="checkbox"/>	<input checked="" type="checkbox"/>	<input type="checkbox"/>
5 Avantgates 5.0 Compact Plus V-DA	4,50	1,05 ÷ 1,50	100x25 mm - Aluminium	WITH INVERTER	15	<input checked="" type="checkbox"/>	<input checked="" type="checkbox"/>	<input type="checkbox"/>



NOTA BENE: i cancelli serie COMPACT possono essere ordinati anche in versione DOPPIA.

NOTE: the gates COMPACT series can also be ordered in DOUBLE version.

Avantgates 5.0 Compact NKD **Carico massimo ammissibile - Maximum allowable load**

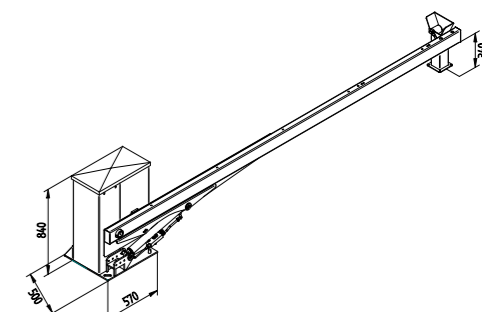
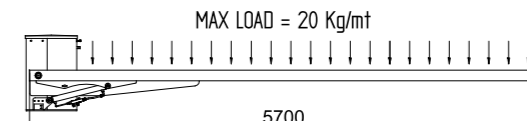
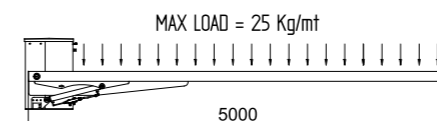
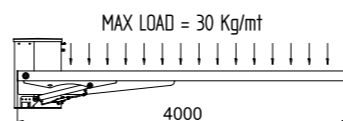

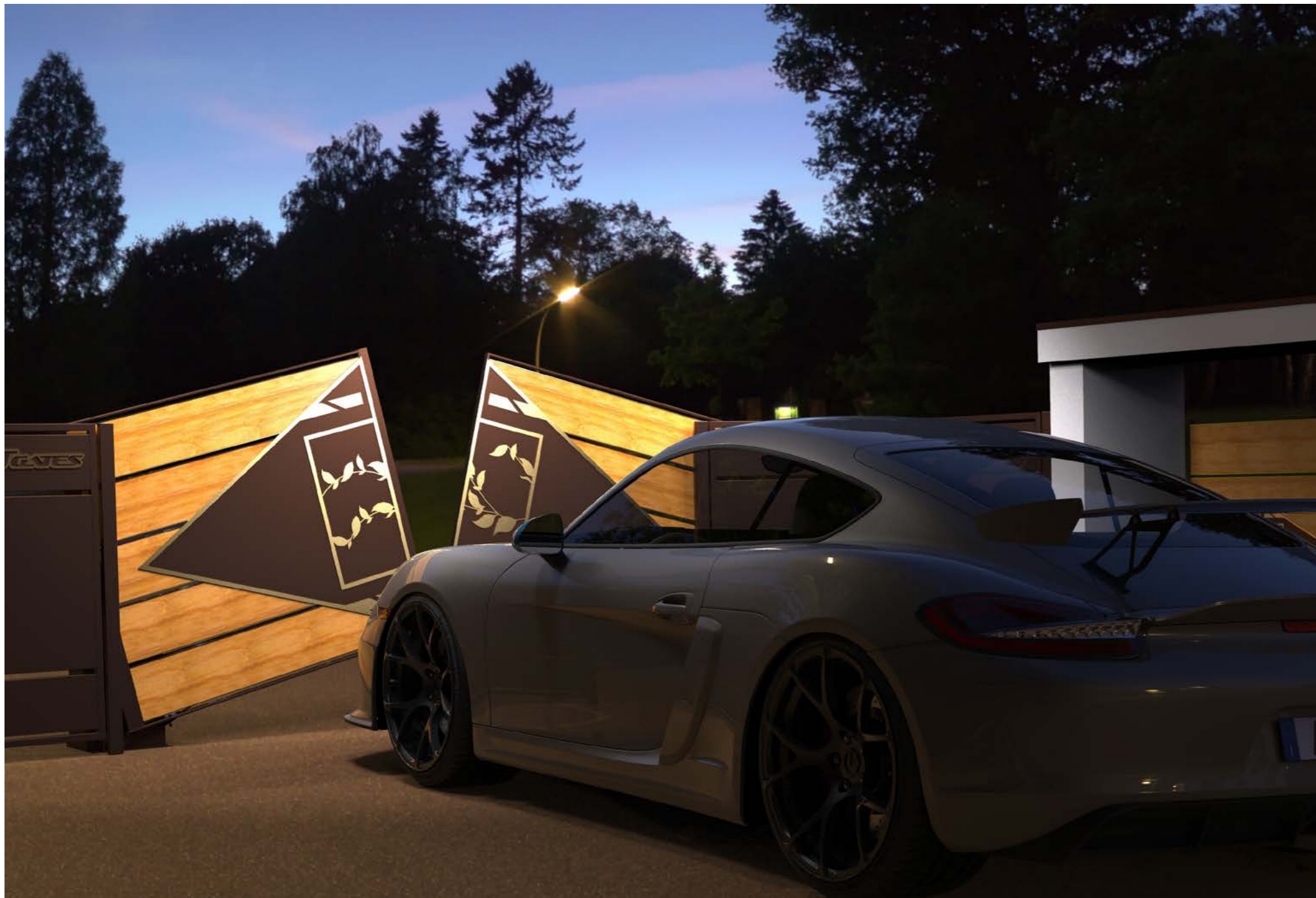





5.0 COMPACT 



COMPACT series

-  The double version of the COMPACT NKD model allows you to configure the vertical gate with any type of fence available on the market. It is therefore possible to create an infinite series of new models for the customer, with an attractive design, while maintaining all the peculiarities of the vertical gate.
-  Mit der Doppelversion des COMPACT NKD können Sie die vertikale Hubtür mit jedem auf dem Markt erhältlichen Zauntyp konfigurieren. Es ist daher möglich, eine unendliche Reihe neuer Modelle für den Kunden zu erstellen, mit einem attraktiven Design, während alle Besonderheiten des vertikalen Tors beibehalten werden.
-  La version double du modèle COMPACT NKD vous permet de configurer le hayon élévateur vertical avec tout type de clôture disponible sur le marché. Il est donc possible de créer une série infinie de nouveaux modèles pour le client, avec un design attrayant, tout en conservant toutes les particularités de la porte verticale.
-  La versione doppia del modello COMPACT NKD permette di configurare il cancello ad alzata verticale con qualsiasi tipo di recinzione presente in commercio. È possibile pertanto creare per il cliente un'infinita serie di nuovi modelli, dal design accattivante, pur mantenendo al tempo stesso tutte le peculiarità del cancello verticale.



5.0 COMPACT  



Avantgates 5.0 Compact PNL-CP Double



Avantgates 5.0 Compact PNL-CA Double

5.0 COMPACT  



PNL-CA DOUBLE **PATENTED**
EUIPO 007055702-0001



Papillon Series
PNL-CP DOUBLE **PATENTED**
EUIPO 007055702-0001

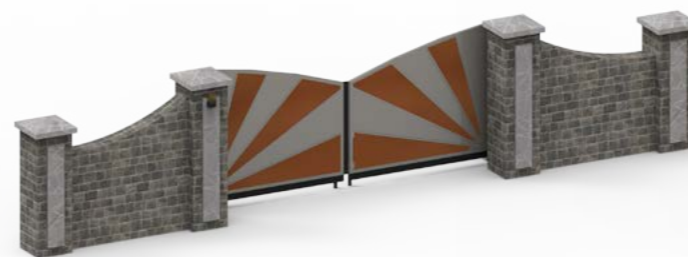

AVANTGATES 5.0 COMPACT

AVANTGATES 5.0 COMPACT



Avantgates 5.0 Compact AFL



Avantgates 5.0 Compact AFL-CP



Avantgates 5.0 Compact AFL-C



Avantgates 5.0 Compact AFL-C Double

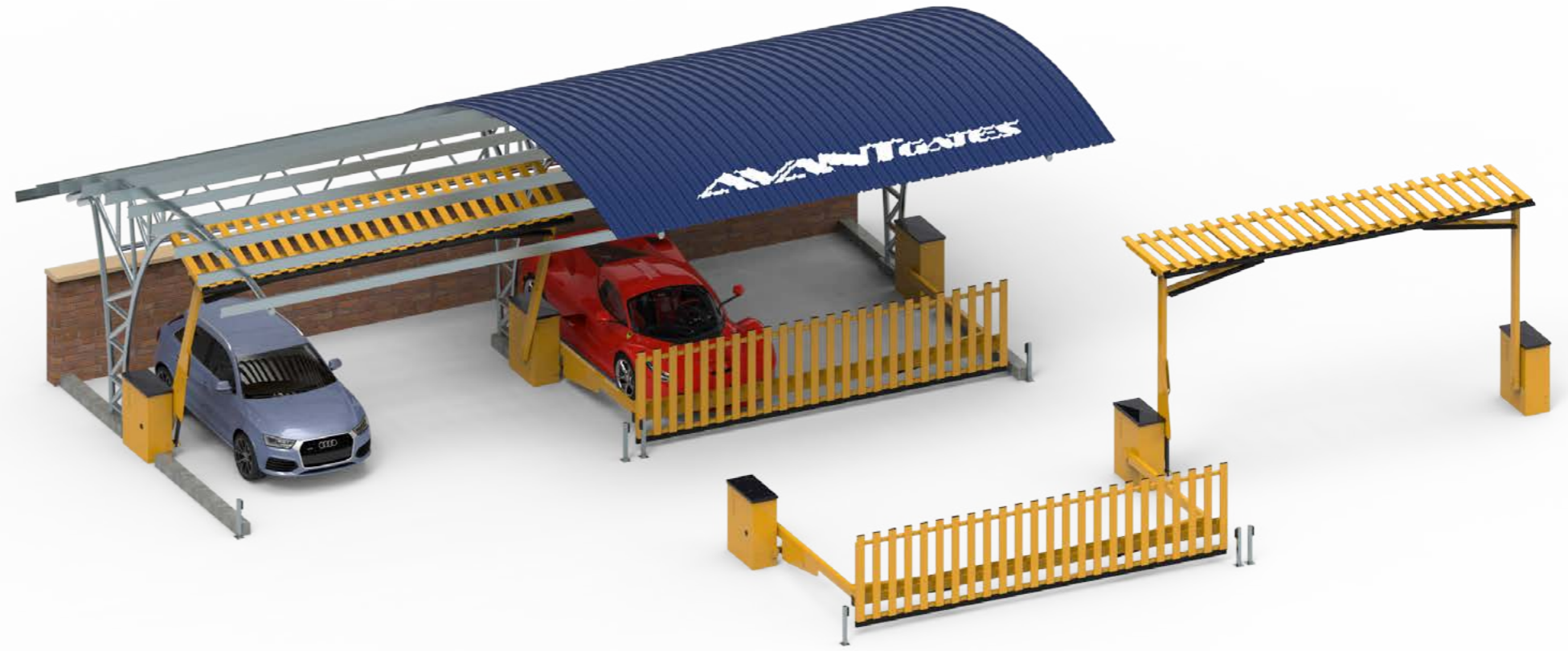

5.0 COMPACT  



Vertical Gates - Vertikaltor - Portail à Elévation Verticale - Cancelli ad Alzata Verticale

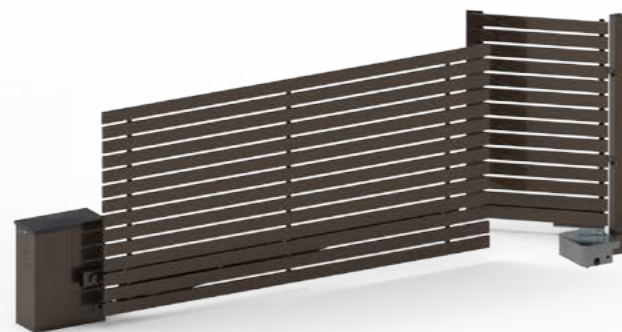

Avantgates 5.0 Compact PNL-CP



5.0 COMPACT  



Vertical Gates - Vertikaltor - Portail à Elévation Verticale - Cancelli ad Alzata Verticale

BARRIERA A TENUTA STAGNA
WATERTIGHT BARRIER



5.0 PHOTO GALLERY



5.0 PHOTO GALLERY





5.0 PHOTO GALLERY





5.0 PHOTO GALLERY

